

MODEL NUMBER:

- ☐ **R510 Rough Valve Body only**
1/2" NPT inlets/outlets. LESS Trim.
- ☐ **R530 Rough Valve Body only**
3/4" NPT inlets/outlets. LESS Trim.

NOTE:

- Requires separate on/off volume control.
 - When used as a Bath/Shower:
 - EITHER
 - must use separate on/off volume control for each spray outlet
 - OR
 - a diverter tub spout (requires twin ell - Model #8888.120)
- IS REQUIRED

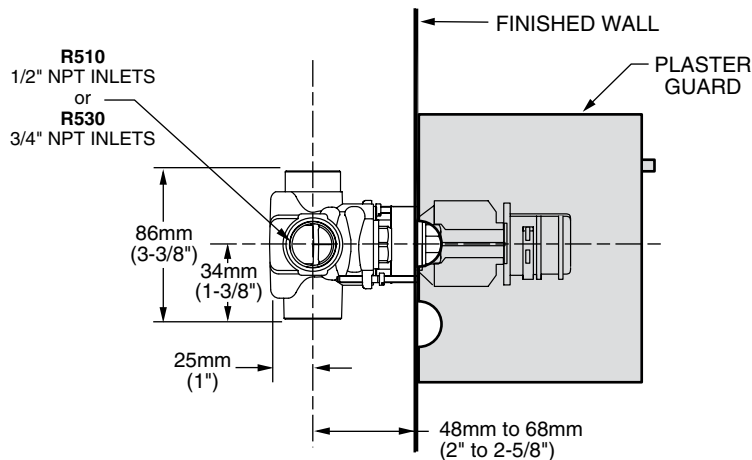

GENERAL DESCRIPTION:

Cast brass valve body. The single unit contains one handle, which sets the desired temperature. The temperature is maintained by a wax element moving a shuttle valve between hot and cold. Includes Hot Limit Safety Stop. Maximum temperature limit is 112°F. Escutcheon plate is stamped brass. Available with 1/2" or 3/4" NPT inlets and outlets. The valve has a high flow rate, ideal for multiple outlet installations.

PRODUCT FEATURES:

- Brass Casting:** Highest quality faucet material for durability & long life.
- Wax Thermostatic Unit:** Permits shuttle valve to move between the hot and cold seats to maintain the pre-selected constant water temperature.
- Back to Back Capable:** Hot and cold can be reversed.
- Spring-Loaded Check Valves:** When the hot and cold water enters the fitting, both supplies pass through the spring-loaded check valves to prevent cross flow of hot and cold water.
- Integrated Stop Valves:** Ensure easy cleaning and servicing.
- Adjustable Hot Limit Safety Stop:** Limits the amount of hot water allowed to mix with cold. Reduces the risk of accidental scalding. Maximum water temperature limit may be reduced to 104 or 109 degrees Fahrenheit.

SUGGESTED SPECIFICATION:

Central Thermostat shall feature a cast brass valve body. Thermostat shall be a wax element shuttle valve. Shall also feature 1/2" or 3/4" NPT inlets and outlets. Fitting shall be American Standard Model # R5_0.

CODES AND STANDARDS

These products meet or exceed the following codes and standards:

- ASSE 1016
- ASME A112.18.1
- CSA B125.1

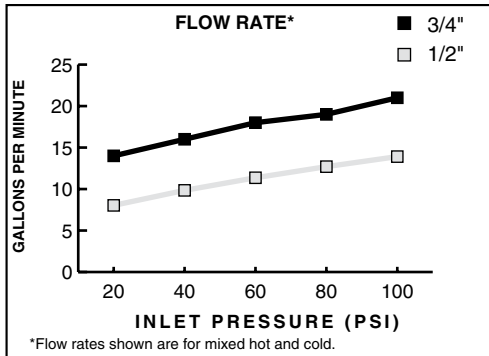











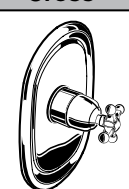

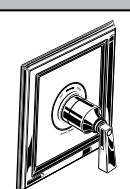

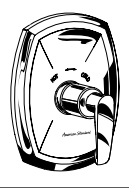

 Meets the American Disabilities Act Guidelines and **ANSI A117.1** Requirements for the physically challenged.

ROUGH VALVE BODIES**	Product Number	Description
	R510*	Rough Valve Body less trim. 1/2" inlets/outlets.
	R530*	Rough Valve Body less trim. 3/4" inlets/outlets.

***NOTE:** • When used as a Bath/Shower a separate on/off volume control for each spray outlet must be used.
Requires twin ell - (Model #8888.120 - must be ordered separately) for use with diverter spouts.
 • Requires separate on/off volume control.

**** ROUGH & TRIM MUST BE ORDERED SEPARATELY.**

R510 and R530 will accept the following trims:

AVAILABLE TRIM KITS	Enfield® Lever	Enfield Cross	Ceratherm™	Ceratherm II	Town Square®	Serin™
						
	T373.730 	T373.732	T050.110	T203.730	T555.730 	T064.730 
	Green Tea®	Copeland™	Moments™	Berwick™	Berwick	
						
	T010.730 	T005.730 	T506.730 	T430.730 	T430.732	